

MAC10 Series Digital controller

Instruction Manual

Thank you for purchasing SHIMAX product. Please check that the product is the one you ordered.
Please operate after you read the instruction manual and fully understand it.

Notice: Please ensure that this manual is given to the final user of the instrument.

Contents

Preface	2
1. Matters regarding safety	2
2. Introduction	2
2-1. Check before use	2
2-2. Caution for use	2
3. Installation and wiring	2
3-1. Installation site (environmental conditions)	2
3-2. Mounting	2
3-3. External dimension and panel cutout	3
3-4. Wiring	3
3-5. Terminal arrangement diagram	4
4. Description of front panel	4
4-1. Names of front panel	4
4-2. Explanation of front panel section	4
5. Description of screens	5
5-1. How to move to another screen	5
5-2. Setting Method	5
5-3. Power-on and initial screen display	5
5-4. Explanation of each screen	6
(1) Basic screens	6
(2) FIX (constant value control) setting screens	6
(3) Mode 1 screens	7
(4) Mode 2 screens	7
(5) Mode 3 screens	7
(6) Mode 5 screens	8
(7) Mode 9 screens	9
5-5. Measuring range code table	9
6. Supplementary Explanation of Function	9
6-1. Auto return function	9
6-2. Output Soft Start Function	9
6-3. Event Selection Alarm Operation Figure	9
6-4. Event Delay & Timer function	9
6-5. AT (Auto Tuning)	9
7. Trouble Shooting	10
7-1. Cause and Treatment of Main Defects	10
7-2. Cause and Treatment of Error Display	10
8. Numeric value and character display on LED	10
9. Specification	10

SHIMAX CO.,LTD.

MAC10F-2AE December, 2014

Preface

This instruction manual is intended for those who will be involved in wiring, installation, operation and routine maintenance of the MAC10.

This manual describes the care, installation, wiring, function, and proper procedures regarding the operation of MAC10.

Keep this manual on hand while using this device. Please follow the provided guidance.

1. Matters regarding safety

For matters regarding safety, potential damage to equipment and/or facilities and additional instructions are indicated as follows:

- ⊙ This mark indicates hazardous conditions that could cause injury or death of personnel. Exercise extreme caution as indicated.

⚠ WARNING

- ⊙ This mark indicates hazardous conditions that could cause damage to equipment and/or facilities. Exercise extreme caution as indicated.

⚠ CAUTION

- ⊙ This mark indicates additional instructions and/or notes.

NOTE

⚠ WARNING

MAC10 is designed for controlling temperature, humidity, and other physical subjects in general industrial facilities. It must not be used in any way that may adversely affect safety, health, or working conditions.

⚠ CAUTION

To avoid damage to the connected equipment, facilities or the product itself due to a fault of this instrument, safety countermeasures must be taken before usage, such as proper installation of the fuse and the overheating protection device. No warranty, expressed or implied, is valid in the case of usage without having implemented proper safety countermeasures.

⚠ WARNING

- The ⚠ mark on the plate affixed to the instrument:
On the terminal nameplate affixed to the case of your instrument, the ⚠ mark is printed. This is to warn you of the risk of electrical shock which may result if the charger is touched while it is energized.
- The external power circuit connected to the power terminal of this instrument must have a means of turning off the power, such as a switch or breaker. Install the switch or breaker adjacent to the instrument in a position which allows it to be operated with ease, and with an indication that it is a means of turning off the power. Use a switch or breaker, which meets the requirements of IEC947.
- Fuse:
Since the instrument does not have a built-in fuse, do not forget to install a fuse in the power circuit to be connected to the power terminal. The fuse should be positioned between the switch or breaker and the instrument and should be attached to the L side of the power terminal.
Fuse Rating: 250V AC 0.2A medium lagged or lagged type.
Use a fuse which meets the requirements of IEC127
- Load voltage/current to be connected to the output terminal and the alarm terminal should be within the rated range. Otherwise, the temperature will rise and shorten the life of the product and/or result in problems with the product.
- Voltage/current that differs from input specification should not be connected to the input terminal. It may shorten the life of the product and/or result in problems with the product.
- This instrument has basic insulation between the power supply and the input-output.
When reinforced insulation is needed, the input/output terminals should be connected A: to a device with no exposed chargers, or B: to a device with basic insulation suitable for the highest voltage of power supply and input/output section.
- A signal wire's common mode voltage to ground (signal wires other than contact output including power supply and event) should be less than 30V rms, 42.4V peak, and 60 VDC.

⚠ CAUTION

- All the wires for the interior distribution, except for communication and contact output (including power supply and event), should be less than 30m in length. When the wire's length is 30m or more, or in the case of outdoor wiring, the suitable measure against a lightning surge is required.

2. Introduction

2-1. Check before use

Before using MAC10, please check the model code, the exterior appearance and accessories. Also, make sure that there are no errors, impairs and shortages.

Confirmation of model code: Check that the product you ordered is being delivered properly.

Check the model code of the main body case against the following code table.

Example of model code

MAC10A—	M	C	F—	2	R
1	2	3	4	5	6

Item

1. Series	MAC10A:-96x96mm size digital controller MAC10B:-48x96mm size digital controller MAC10C:-72x72mm size digital controller MAC10D:-48x48mm size digital controller
2. Input	M:multi, I:current
3. Control Output 1	C:contact, S:voltage pulse, I:current(4-20mA),
4. Power Supply	F:-100~240V(90~264V)AC
5. Event Output	N:none, 1:Event Output1 (one point) 2:Event Output1,2 (two points)
6. Communication	N: none, R: RS485

Check of accessories

Instruction manual(excerpt edition): 1 set

「NOTE」: Please contact our agencies or business offices if you have any problem.
We welcome any kind of inquiry such as defect of the product, shortage of accessory and so on.

2-2. Caution for use

- (1) Do not operate the front panel keys with hard or sharp objects.
Do not fail to touch keys lightly with a fingertip.
- (2) Wipe gently with a dry rag and avoid using solvents such as thinner.

3. Installation and wiring

3-1. Installation site (environmental conditions)

⚠ CAUTION

Do not use this product under the following conditions.
Otherwise, failure, damage and fire may occur.

- (1) Where flammable gas, corrosive gas, oil mist or dust generate or grow rife.
- (2) Where the temperature is below 0°C or above 50°C
- (3) Where the humidity is over 90%RH or where condensation occurs.
- (4) Where high vibration or impact occurs
- (5) Where inductive interference may easily affect the operation.
Or, in the region of strong electric circuit area.
- (6) Where waterdrops or direct sunlight exists.
- (7) Where the altitude is above 2,000m.

「NOTE」: The environmental conditions comply with the IEC664.
Installation category is II and the pollution degree is 2.

3-2. Mounting

- (1) Machine the mounting hole by referring to the panel-cut illustration in Section 3-3.
- (2) Applicable thickness of the mounting panel is 1.2~2.8mm.
- (3) As this product provides mounting fixture, insert the product into the panel.

3-3. External dimension and panel cutout

MAC10 external dimensions (unit: mm)

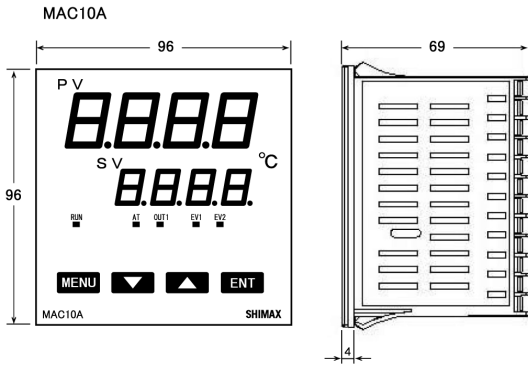

MAC10B 48x96size

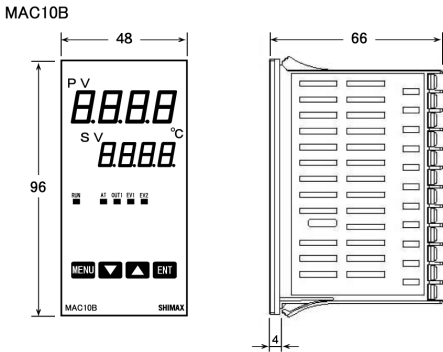
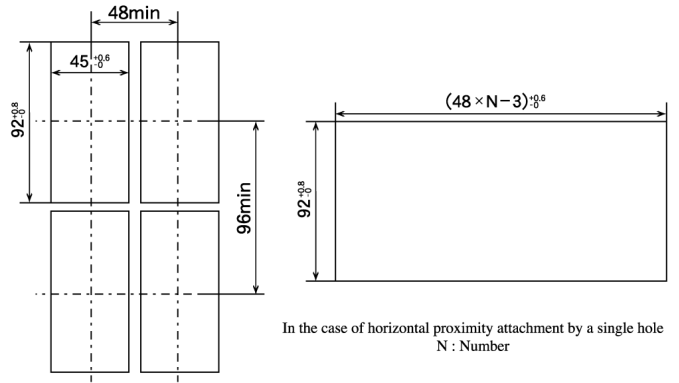

MAC10C 72x72size

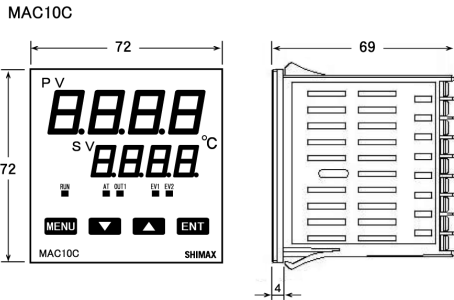
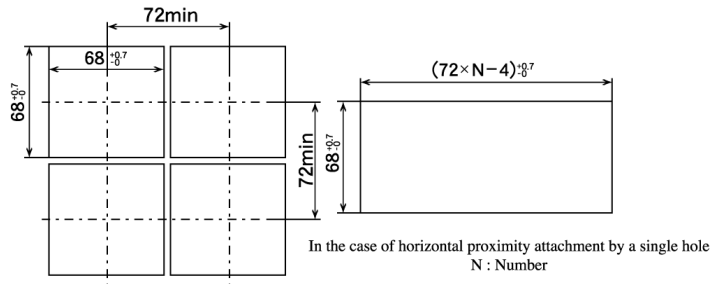

MAC10D 48x48size

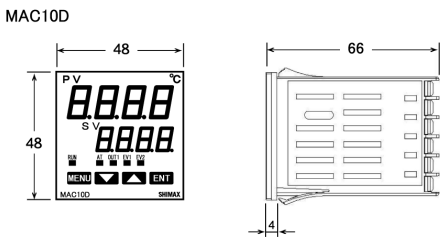
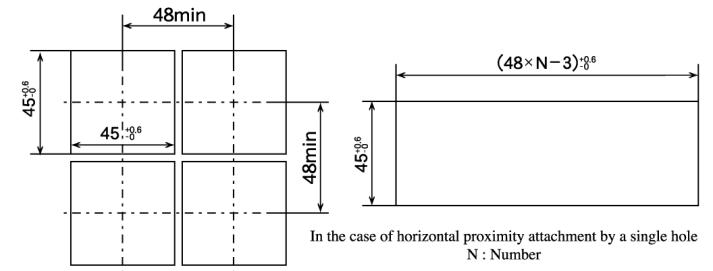

Note: Proximity attachment by a single hole is possible only in the case of horizontal direction. When an apparatus that was attached in vertical direction is removed, a dedicated detachment tool is required.

3-4. Wiring

⚠ WARNING

Do not turn on electricity while wiring to avoid an electric shock.
Do not touch a terminal or live part while turning on electricity.

- (1) Make sure that wiring operation is properly done in line with a terminal wire diagram of section 3-5.
- (2) Choose a suitable compensation lead wire in the case of thermocouple input.
- (3) In the case of resistance bulb input, resistance value of each lead wire must be less than 5Ω and that of three lead wires must be equal.
- (4) Do not wires an input signal line inside of an electric wire pipe or a duct same with the high voltage line.
- (5) Shield wiring (single point grounding) is effective against static induction noise.
- (6) Wiring twisted at equal short intervals is effective against electromagnetic induction noise.

MAC10 panel cutout (unit: mm)

MAC10A 96x96size

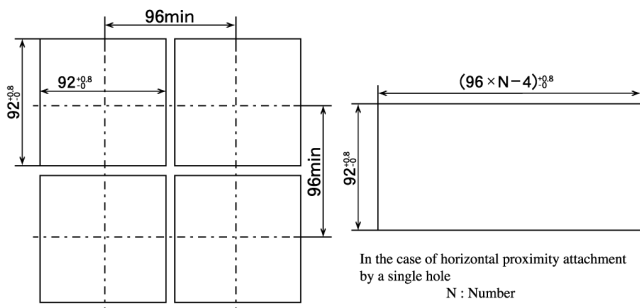

3-5. Terminal arrangement diagram

Terminal arrangement plan of MAC10A and MAC10B

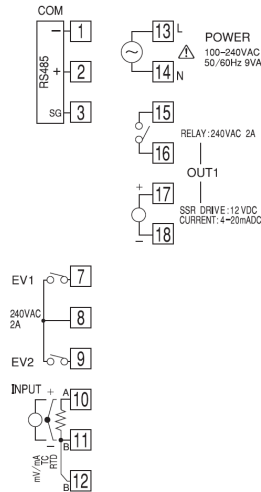

[Note] : If input type is thermocouple or voltage, errors may occur when terminal 11 and terminal 12 terminal are short-circuited

Terminal arrangement plan of MAC10C

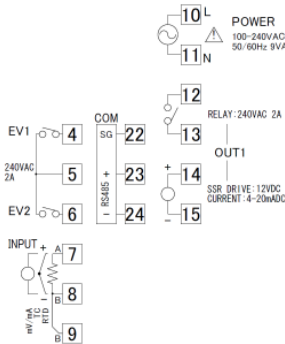

[Note] : If input type is thermocouple or voltage, errors may occur when terminal 8 and terminal 9 terminal are short-circuited

Terminal arrangement plan of MAC10D

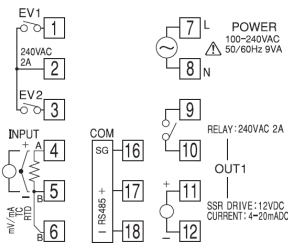

[Note] : If input type is thermocouple or voltage, errors may occur when terminal 5 and terminal 6 terminal are short-circuited

4. Description of front panel

4-1 Names of front panel

MAC10A 96x96size front

MAC10C 72x72size front

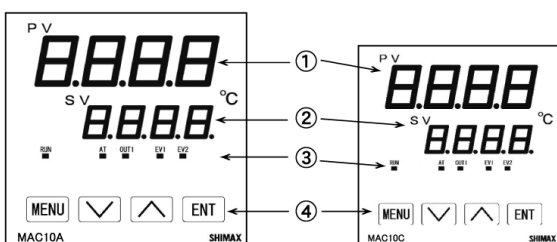

MAC10D 48x48size front

MAC10B 48x96size front

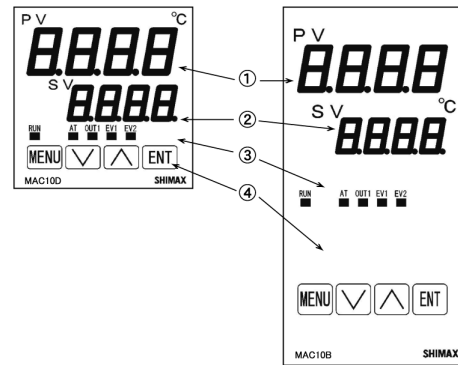

4-2. Explanation of front panel section

- ① : Display of process value (PV) (red)
Process value and type of setting is displayed on each setting screen.
- ② : Display of set value (SV) (green)
Set value is displayed on each setting screen.
- ③ : Monitor LED
 - (1) RUN monitor LED (green)
If RUN is performed with operation mode screen, and communication, it lights up, and put out by standby. It blinks, if a manual output is chosen in output monitoring screen.
 - (2) Auto tuning operation monitor LED (green)
If AT is chosen in ON, blinks during AT execution. Lights up when AT is on standby, and puts out with AT automatic termination or release.
 - (3) Control output 1 monitor LED (green)
At the time of a contact or a voltage pulse output, it lights up with ON and lights off with OFF. Lights off with 0% power output, and lights up with 100% power. And blinks in intermediate ratio.
 - (4) Event output monitors LED (yellow)
Lights up when the allotted event output turns to ON.
- ④ : Key-switch section
 - (1) **MENU** (MENU) key
Press this key to move onto the next screen among the screens. Press **MENU** key for three seconds on the basic screen, then it jumps to the lead screen of Mode 1. Press **MENU** key for three seconds on the lead screen of each Mode screens, then it jumps to the basic screen. Press **MENU** key for three seconds on the lead screen of FIX, then it jumps to the basic screen.
 - (2) **DOWN** (DOWN) key
Press **DOWN** key one time, and the shown value decreases by one numerical value. One time press of **DOWN** key decreases by one numerical value. By pressing the key continuously, the value as well consecutively decreases. A decimal point of the smallest digit blinks at this time. This shows that a setting change is in progress.
 - (3) **UP** (UP) key
Press **UP** key one time, and the shown value increases by one numerical value. By pressing continuously, the value by pressing the key continuously, the value consecutively increases. A decimal point of the smallest digit blinks at this time. This shows that a setting change is in progress.

Supplementary explanation of **UP** key and **DOWN** key

When you continue pressing up/down keys, and press an opposite key, change in the value becomes 1 stage faster. (When the key is pushed for 4 times, it becomes high-speed.)

- (4) **ENT** (ENTRY/REGISTER) key
The setting data changed on each screen is determined (the decimal point of the minimum digit is also lighted off).
Press **ENT** key for 3 seconds on the output monitoring screen, then the shift between manual output and automatic output is carried out.
Press the key for 3 seconds on the basic screen, then it shifts to FIX head screen. Push at FIX and each mode screens' lead screen, then shifts to setting screen.

5. Description of screens

5-1. How to move to another screen

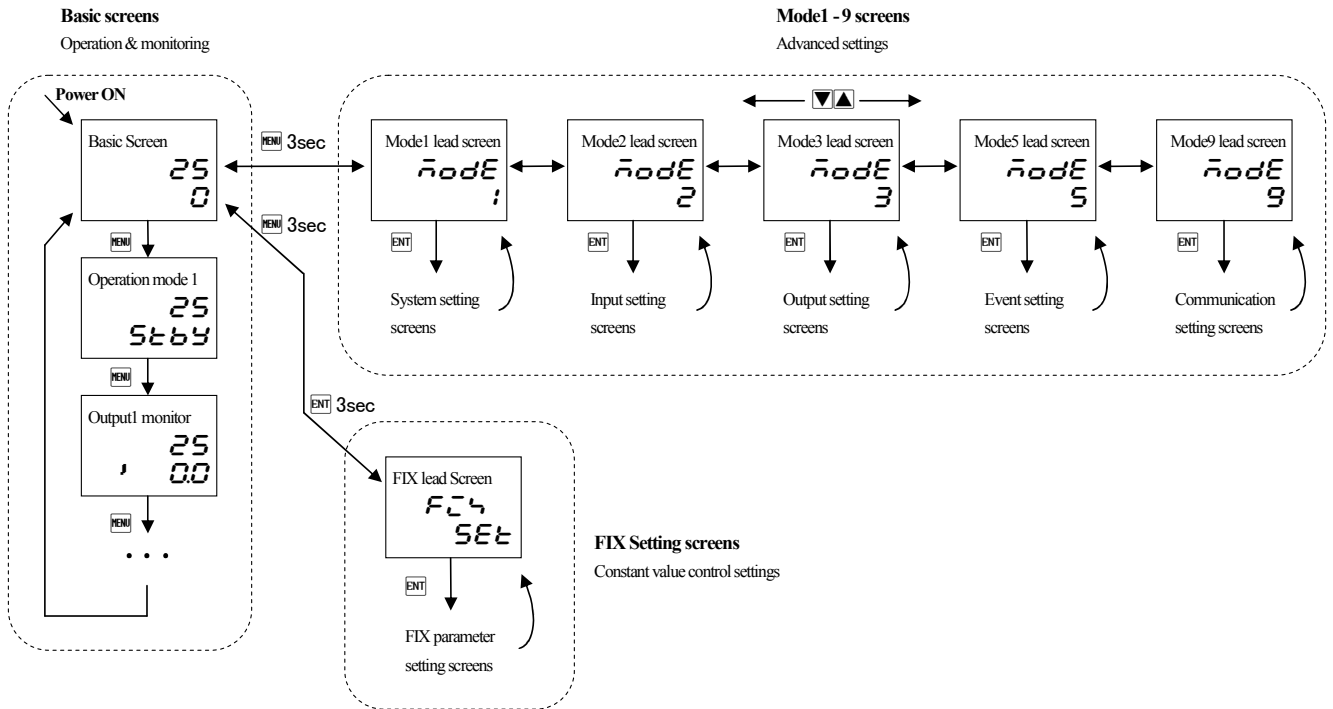

Every time you press the **MEM** key on a basic screen, it shifts to each screen of the basic screens.

Press the **MEM** key for 3 seconds on a basic screen, then it shifts to the lead screen of mode 1 screens.

Press the **MEM** key for 3 seconds on the lead screen of mode 1 ~ 9 screens, then it shifts to the basic screen.

Press the **▲** key on the lead screen of mode 1 screens, then it further advances to mode 2, and mode 3. (Notes: If no corresponding option is found, the mode 4-9 is skipped)

Press the **▼** key on the lead screen of mode 1 screens, then it further advances to mode 9, and mode 8. (Notes: If no corresponding option is found, the mode 4-9 is skipped)

Press the **ENT** key on the lead screen of mode 1 ~ 9 screens, then it shifts to the first setting screen of each screens.

Press the **MEM** key on the first setting screen of each screens, then it shifts to the next screen. Every time you press the **MEM** key, it shifts to the next setting screen.

Press the **ENT** key for 3 seconds on a basic screen, then it shifts to the lead screen of F24 (constant value control) setting screens.

Press the **MEM** key for 3 seconds on F24 the lead screen of setting screens, then it shifts to the basic screen.

5-2. Setting Method

● Variables and settings

To change settings, display an appropriate screen and change the setting (value or function) by pressing **▲** or **▼** key, And press the **ENT** key (The decimal point of the minimum digit is also lighted off).

● Automatic and Manual output setting

On the output monitor screen of basic screens, you can change the control output from "Automatic" to "Manual", and save its change of setting. Display the output monitor screen, and then press **ENT** key for three seconds to shift from Automatic to Manual. Then by pressing **▲** or **▼** key, you can adjust to the desirable output value. In this case, no need to press **ENT** key in order to determine the change of setting.

Press **ENT** key for three seconds as well to shift back to Automatic. Excluding when a keylock is OFF, Automatic ↔ Manual switchover does not work while STIBY and AT are in operation.

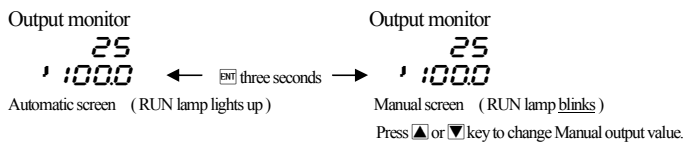

5-3. Power-on and initial screen display

At power-on, the display section shows each screen of initial screens for one second, then moves on to the basic screen.

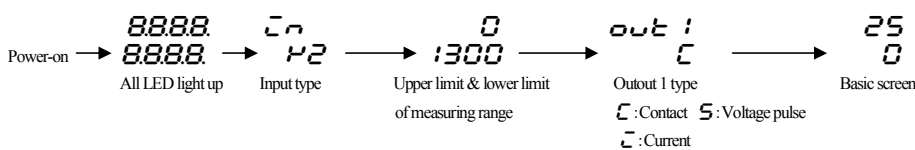

(3) Mode 1 screens

Mode 1 lead screen

mode Press **ENT** key for 3 seconds on basic screen, then displayed

!
ENT key No setting on this screen. Press the **ENT** key, then it shifts to the first setting screen, keylock setting screen.

Keylock setting screen

LOCK Initial value : **OFF**
OFF Setting range : **OFF, 1, 2, 3, 5**

- ENT** key
- !** Execution SV (basic screen), Manual output value, and keylock level is possible.
 - 2** Manual output value and key lock level is possible.
 - 3** Only change of a keylock is possible.
 - 5** Change of key lock level and Basic screens are possible.

Notes: Even when keylock is set as 1 and 2, manual output value is possible to change.

SV limiter lower limit setting screen

SV_L Initial value : measuring range lower limit
0 Setting range : measuring range lower limit value~measuring range upper limit value-1

ENT key And **BLP** (SV display turn off)
Lower limit value of set value is set.
When upper limit value is smaller than lower limit value, the value compulsorily becomes lower limit value+1.
When you choose **BLP** pressing **ENT** at lower limit value, the SV display turn off at basic screen. But it will turn on at the setting screen.

SV limiter upper limit value setting screen

SV_H Initial value : measuring range upper limit
1000 Setting range : SV limiter lower limit value +1~measuring range upper limit value
ENT key Setting upper limit value of set value is set.

Operating mode after power-on setting screen

Power Initial value : EEP
EEP setting range : EEP RUN/STBY status save to non-volatile memory automatically.
ENT key STBY Operation mode is STBY after power-on.
RUN Operation mode is RUN after power-on.

Return to mode 1 lead screen.

(4) Mode 2 screens

Mode 2 lead screen

mode Press **▲** key in mode 1 lead screen, or press **▼** key in mode 3 lead screen, then being displayed.

If **ENT** key is pressed, it shifts to the first setting screen PV offset correction screen.

ENT key

PV offset correction setting screen

PV_o Initial value : 0
0 Setting range : -500~500 Digits

ENT key Used for correction of input errors such as sensor.
If offset correction is performed, control is also performed with the corrected value.

PV gain correction setting screen

PV_G Initial value : 0.00
000 Setting range : ±5.00%

ENT key Maximum input value is corrected within limit of ±5.00% of measuring range.
If corrected, inclination of spang changes in straight line which connects zero point and correction maximum value.

PV filter setting screen

PV_F Initial value : 0
0 Setting range : 0 ~ 100 seconds

ENT key When input change is violent or noise is overlapped, used in order to ease the influences.
In 0 second setting, filter does not function.

Measuring range setting screen

rRrC Initial value : multi input **P2**, current input **AR** ;
P! Setting range : Chosen from 5-5.measuring range code table.

ENT key Combination of input type and measuring range is set by code.

Input scaling lower limit value setting screen

Sc_L Initial value : 0.0
00 Setting range : -1999 ~ 9989 digits
ENT key Scaling lower limit value at the time of linear input is set up.
Displays at the time of linear input.

Input scaling upper limit value setting screen

Sc_H Initial value: 100.0
1000 Setting range: -1989 ~ 9999 digits
ENT key Scaling upper limit value at the time of linear input is set up.
Displays at the time of linear input.

NOTE: Suppose that the difference between a lower limit value and upper limit value is 10 or less, or over 10000. In this setting, upper limit value is compulsorily changed into that of +10 or ± 10000 count. Upper limit value cannot be set as lower limit value of +10 count or less, or that of over 10000 count.

Input scaling Decimal point position Setting screen

dP Initial value: the first place after decimal point (0.0)
00 Setting range: no decimal point 0~the third place after decimal point(0.000)
ENT key Decimal point position of input scaling is set.
Displays at the time of linear input.

Open thermocouple detection Setting screen

tc_b Initial value : H
H Setting range : H, L
ENT key Direction of the open thermocouple detection (High or low).
Displays at the time of Thermocouple input.

Return to mode 2 lead screen.

(5) Mode 3 screens

Mode 3 lead screen

mode No setting on this screen.
3 If **ENT** key is pressed, it shifts to the first setting screen, output 1 proportional band setting screen. In this screens, PID settings in output 1 and soft start of output 1, and proportional period output characteristics are set up.

Output 1 PID proportional-band (P) setting screen

P Initial value : 3.0%
30 Setting range : OFF, 0.1 ~ 999.9%
ENT key When performing auto tuning, no necessity for a setting basically.
If OFF is chosen, it becomes ON-OFF (two positions) operation.

Output 1 PID Integral time (I) setting screen

I Initial value: 120 seconds
120 Setting range: OFF, 1~6000 seconds
ENT key When performing auto tuning, no necessity for a setting basically.
This screen is not displayed at the time of ON-OFF operation.
Becomes P operation or PD operation in I=OFF setting.

Output 1 PID Derivative time (D) setting screen

d Initial value: 30 second
30 Setting range: OFF, 1~3600 seconds
ENT key When performing auto tuning, no necessity for a setting basically.
This screen is not displayed at the time of ON-OFF operation.
Becomes P operation or PI operation in D=OFF setting.

Output1 PID manual reset setting screen

̄r Initial value : 0.0
0.0 Setting range : -50.0 ~ 50.0%
 [F4] key
 The offset correction at the time of I=OFF (P operation,PD operation) is performed.
 This screen is not displayed at the time of ON-OFF operation.

Output 1 ON-OFF operation lowside differential-gap setting screen

dFL Initial value : 5
S Setting range : 1 ~ 999 unit
 [F4] key
 The lowside differential gap at the time of ON-OFF operation is set.
 Displayed at the time of P=OFF (ON-OFF operation) setup.

Output 1 ON-OFF operation highside differential-gap setting screen

dFH Initial value : 5
S Setting range : 1 ~ 999 unit
 [F4] key
 The highside differential gap at the time of ON-OFF operation is set.
 Displayed at the time of P=OFF (ON-OFF operation) setup.

Output1 PID minimum limiter setting screen

oL Initial value : 0.0
0.0 Setting range : 0.0~99.9%
 [F4] key Output lower limit value of output 1 PID is set up.

Note: At the time of STBY and scale over output, limiter value is disregarded.

Output 1 PID maximum limiter setting screen

oH Initial value :100.0
:000 Setting range : output limiter lower limiter values +0.1~100.0%
 [F4] key Upper limit value of output 1 PID is set.

Output 1 soft starting time setting screen

SoF Initial value : OFF
oFF Setting range :OFF, 0.5~120.0 seconds (setting resolution 0.5 second)
 [F4] key This is the function that eases change of output at the time of a power-on and start up.
 Does not function at the time of OFF setup.

Output 1 proportional periodic time setting screen

oC Initial value : Contact output 30.0 seconds
300 Voltage pulse output 3.0 seconds
 [F4] key Setting range : 0.5~120.0 seconds (setting resolution 0.5 second)
 Proportional periodic time of output 1 is set.
 Not displayed when output 1 is current output.

Output 1 characteristics setting screen

AcE Initial value : rR
rR Setting range : rR, dR
 [F4] key Characteristics of control output is chosen from rR (heating characteristics) and dR (cooling characteristics).

Return to mode 3 lead screen

(6) Mode 5 screens

Mode 5 screens is the setup screens of event option. Not displayed when option is not added.

Mode 5 lead screen

̄odE No setting on this screen.
S Press [F4] key, it shifts to the first setting screen, event 1 operation-mode setting screen.

Event 1 operation-mode setting screen

E ! ̄ Initial value : non
non Setting range : Chosen from event type character table.
 [F4] key
 Event type allotted to event 1 is chosen from character table.

Event type character table

Character	Type
non	No allotment
HR	Upper limit absolute value alarm
LR	Lower limit absolute value alarm
So	Scale over alarm
Hd	Maximum deviation alarm
Ld	Minimum deviation alarm
̄d	Within deviation alarm
od	Without deviation alarm
run	RUN signal

※ Being initialized if measuring range, scaling, and unit are changed.

※ Deviation alarm is possible to output at the time of RUN+AUTO.

In other events, output is always possible.

Event 1 differential-gap setting screen

E ! d Initial value : 1 Digits
! Setting range : 1~999 Digits
 [F4] key ON-OFF differential gap of event 1 is set.
 Not displayed, when the event 1 mode are as follows: non, So, run.
 Change in measuring range, scaling, unit, and the event 1 mode make it initialize.

Event 1 standby operation setting screen

E ! S
oFF Initial value : oFF
! Setting range : oFF, 1, 2
 [F4] key
oFF :No standby operation, **!** : standby-operation only at the time of a power-on.
2 :Standby-operation in the following cases :
 At the time of power-on,
 When each alarm's operating point is changed,
 When deviation alarm's SV is performed,
 When RUN/STBY is switched,
 When AUTOMAN is switched.
 Not displayed, when the event 1 mode are as follows : non, So, run.
 Change in measuring range, scaling, unit, and the event 1 mode make it initialize.

Event 1 Delay mode setting screen

E ! P Initial value : dELY
dELY Setting range : dELY, t̄r 1, t̄r 2
 [F4] key Event1 delay mode : Delay, Timer1, Timer2
 Refer to 6-4 Event Delay & Timer function.
 Not displayed, when the event 1 mode are as follows non.
 Change in measuring range, scaling, unit, and the event 1 mode make it initialize.

Event1 ON Delay time setting screen

E ! dn Initial value : OFF
oFF Setting range : OFF, 1~8000 second
 [F4] key ON Delay time of Event1 delay function is set.
 Not displayed, when the event 1 mode is non, or Delay mode is Timer.
 Change in measuring range, scaling, unit, and the event 1 mode make it initialize.

Event1 OFF Delay time setting screen

E ! dF Initial value : OFF
oFF Setting range : OFF, 1~8000 second
 [F4] key OFF Delay time of Event1 delay function is set.
 Not displayed, when the event 1 mode is non, or Delay mode is Timer.
 Change in measuring range, scaling, unit, and the event 1 mode make it initialize.

Event 1 Timer ON time setting screen

E ! t̄n Initial value : 1
! Setting range : 1~600
 [F4] key ON period of Event1 Timer function is set.
 Not displayed, when the event 1 mode is non, or Delay mode is Delay.
 Change in measuring range, scaling, unit, and the event 1 mode make it initialize.

Event 1 Timer OFF time setting screen

E ! t̄F Initial value : 0
0 Setting range : 0~600
 [F4] key OFF period of Event1 Timer function is set.
 Not displayed, when the event 1 mode is non, or Delay mode is Delay.
 Change in measuring range, scaling, unit, and the event 1 mode make it initialize.

Event 1 Timer unit setting screen

E 1 T U Initial value : **0000**
0000 Setting range : **0000**(minute), **SEC**(second)
 [F5] key Time unit of Event1 Timer function is set.
 Not displayed, when the event 1 mode is **non**, or Delay mode is Delay.
 Change in measuring range, scaling, unit, and the event 1 mode make it initialize.

Event 1 latching setting screen

E 1 L Initial value : **OFF**
OFF Setting range : **OFF, ON**
 [F5] key
 When latching is set as **ON**, once event is output, even if event is OFF state event output state is held. Not displayed when event 1 mode is **non**.
 Being initialized if measuring range, scaling, and unit are changed.

Event 1 output characteristics setting screen

E 1 R Initial value : **NO**
NO Setting range : **NO, NC**
 [F5] key Output characteristics event 1 is chosen from **NO** : normal open,
NC : normal closing.
 Not displayed when event 1 mode is **non**.
 Note : If **NC** is chosen, relay turns to ON within 1.5 seconds when power source is switched on, and turns to OFF in event output range.

Event 2 setting screens

Following contents are the same with that of an Event1 setting screens.

Return to mode 5 lead screen

(7) Mode 9 screens

A group of Mode 9 screens are communication of RS-485 option setting screens.
 When the option is not added, these screens are not displayed.
 For details, please refer to the instruction manual for communication interface.

5-5. measuring range/code table

Input type		Code	Measuring Range	
			Unit : °C	
Multi input	Thermocouple	K	P1	0 ~ 1300
		K	P2	-50.0 ~ 999.9
		J	J1	0 ~ 600
		J	J2	0.0 ~ 600.0
Resistance Bulb Pt100			P1	-100.0 ~ 200.0
			P2	-100 ~ 200
			P3	-199.9 ~ 300.0
			P4	-200 ~ 300
Volatage(mV) 0 ~ 50		V1	Scaling Range : -1999~9999 Digit	
Current(mA)	4 ~ 20	RA1	Span :10~10000 Digit	
	0 ~ 20	RA2	Change of decimal point's position is possible (no decimal point, 0.1, 0.01, 0.001)	

Thermocouple K, J : JIS/IEC Resistance bulb Pt100 : JIS/IEC
 Setup of factory shipment is Multi input : Thermocouple **P1** (0 ~ 1300°C)
 Current input : 4-20mA **RA1** (0.0 ~ 100.0)

6. Supplementary Explanation of Function

6-1. Auto return function

When there is no key operation 3 minutes or more, on the screen except for basic screen and each monitoring screen, screen automatically shifts to basic screen.

6-2. Output Soft Start Function

This is the function to increase the control output gradually with set-up time at the time of power-on, STBY→RUN, and normal return from scale over. This is effective for controlling the excessive current to loads, such as a heater.

Soft-start functions in the following conditions :

- At the time of the power-on in automatic operation, STBY→RUN, and normal return from scale over.
- Output 1 setting is not ON-OFF operation (Setup of proportional band (P) is other than OFF)
- Soft starting time is not OFF

6-3. Event Selection Alarm Operation Figure

The figure of alarm operation figure allotted to event 1~2 is shown.

△: SV ▲ or ↔ : Alarm operating point setting value

→ ← : Differential gap

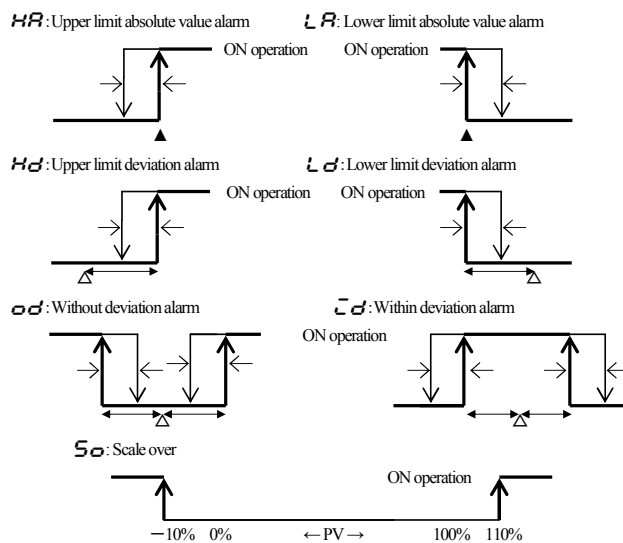

6-4. Event Delay & Timer function

(1) Delay mode

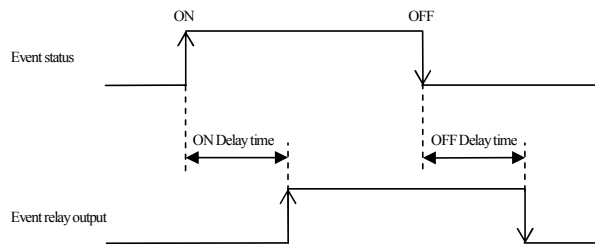

(2) Timer mode

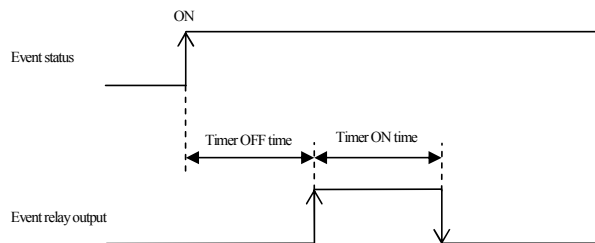

※Difference of Timer 1 and Timer 2

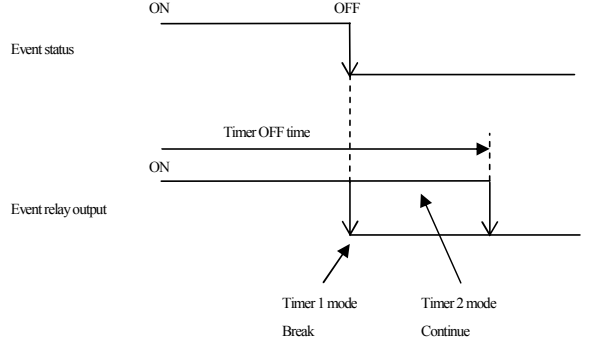

6-5. AT (Auto Tuning)

- If AT is performed by FIX (constant value control), AT monitor LED blinks and light is put out by termination or intermediate release.
- When auto tuning is ended in inclination step or chosen all PID(s), it is in standby state until one pattern is completed. Then lights up, then puts out when one pattern is completed.
- When AT is not completed within 1 pattern, AT conducting is released when one pattern is completed.

7. Trouble Shooting

7-1. Cause and Treatment of Main Defects

Contents of defects	Cause	Treatment
Error message display	Refer to "7-2 cause and treatment of error display".	Refer to "7-2 cause and treatment of error display".
PV display is not normal	Mismatch of instrument and input. Fault in the wiring.	Type code, check of specification. Check of wiring.
Display disappeared and does not operate	Power is not supplied. Abnormality of instrument.	Check of a power supply (voltage of terminal, switch, fuse, wiring). Check of instrument, repair, exchange.
Key operation impossible	Keylocked. Abnormality of instrument.	Release of keylock. Check of instrument, repair, exchange.

7-2. Cause and Treatment of Error Display

(1) Abnormality Display of Measurement Input

Error display	Contents	Cause	Treatment
HHHH	Scale over in upper limit	1.wire breaking of thermocouple and mV input 2.wire breaking of resistance bulb input A 3.when input exceeds upper limit of measuring range by 10%	1.wire breaking check of thermocouple and mV input wiring, replacement of thermocouple 2.check of resistance bulb A wiring, replacement of resistance bulb 3.check of input voltage value and current value, input transmitter and specification (matching of incoming signal and meter specification)
LLLL	Scale over in lower limit	1.when input exceeds lower limit of measuring range by 10% 2.wire breaking of resistance bulb input B (B: Wiring of MAC10A/B's terminal No.11, Wiring of MAC10C's terminal No.8, Wiring of MAC10D's terminal No.5)	1.polarity of input is reverse, check of wiring and an input transmitter 2.check of resistance bulb B wiring, replacement of resistance bulb
b---	Breaking of resistance bulb input	1.wire breaking of b (b: Wiring of MAC10A/B's terminal No.12, Wiring of MAC10C's terminal No.9, wiring of MAC10D's terminal No.6) 2.multiple wire breaking combinations in ABb (A and B, A and b, B and b, all of ABb)	1.check of resistance bulb wiring 2.replacement of resistance bulb
εJHH	Cold junction (CJ) temperature of thermocouple input is scale over in upper limit side	When ambient temperature of a meter exceeds 80°C	1.make Ambient temperature of meter within use environment condition temperature 2. Check the meter when ambient temperature is not over 80°C
εJLL	Cold junction (CJ) temperature of thermocouple input is scale over in lower limit side	When ambient temperature of meter becomes less than -20°C	1.make Ambient temperature of meter within use environment condition temperature 2. Check the meter when ambient temperature is not less than -20°C

8. Numeric value and character display on LED

Numeric values

0	1	2	3	4	5	6	7	8	9
0	1	2	3	4	5	6	7	8	9

Alphabetical characters

A	b	Cc	d	E	F	G	Hh	i	J	K	L	M	N
A	B	C	D	E	F	G	H	I	J	K	L	M	N
o	P	q	r	S	t	Uu	v	w	x	y	z	-	-
O	P	Q	R	S	T	U	V	W	X	Y	Z	-	-





9. Specification

Display

Display method	Digital display	MAC10A (96x96 size)	PV red 7 segment LED	4 figure (height of character about 20mm)
			SV green 7 segment LED	4 figure (height of character about 13mm)
		MAC10B (48x96 size)	PV red 7 segment LED	4 figure (height of character about 12mm)
			SV green 7 segment LED	4 figure (height of character about 9 mm)
		MAC10C (72x72 size)	PV red 7 segment LED	4 figure (height of character about 16mm)
			SV green 7 segment LED	4 figure (height of character about 16 mm)
		MAC10D (48x48 size)	PV red 7 segment LED	4 figure (height of character about 12mm)
			SV green 7 segment LED	4 figure (height of character about 9mm)
		Status display	RUN (green), AT (green), OUT 1(green), EV1 (yellow), EV2 (yellow)	
Display accuracy		±(0.5%FS+1digit) CJ errors not included		
Accuracy maintenance range		23±5°C		
Display range		-10%~110% of measuring range, but 0~1300°C of TC(K type) is -30~1320°C, -50.0~999.9°C of TC(K type) is -80.0~1030.0°C		

Display resolution Changes with measuring range and scaling.
 Input scaling Possible at the time of linear(mV, current) input -1999~9999
 (span 10~10000 count, decimal point position no decimal point, 0.1, 0.01, 0.001)

Setting

Setting system By four front keys (   )
 SV Setting range Same with measuring range
 Setting lock Communication and key setting (five levels)

Operations	Level	Lock content
Communication & Key setting	OFF	No lock
	1	Possible to change Execution SV, Manual output value, and keylock level.
	2	Possible to change Manual output value and keylock level.
	3	Possible to change keylock level.
	5	Possible to change basic screens and keylock level.

(Setting lock level 4 is unavailable)

SV setting limiter Same with measuring range (lower limit < upper limit)
 Unit setting At the time of sensor input, °C

Input

Sampling period 0.25 second
 PV filter 0~100 second
 PV offset compensation ±500 unit
 PV gain correction ±5.00%

■Thermocouple

Input resistance 500kΩ or more
 External resistance tolerance level 100Ω or less
 Influence of lead-wire resistance 0.23μV/Ω(up scale), -0.34μV/Ω(down scale) (Typical value)
 Burnout Standard equipment (up scale or down scale)
 Measuring range Refer to 5-5 measuring range code table.
 Compensation accuracy ±2°C (ambient temperature 18~28°C) At the time of vertical plural proximity attachment ±3°C
 of reference junction ±3°C (ambient temperature 0~50°C) At the time of vertical plural proximity attachment ±4°C
 Several minutes after power-on, accuracy is not guaranteed. Reaches the accuracy level within 10 minutes after power-on.
 Tracking of a reference junction Below the ambient temperature of 0.5 °C / min, relative compensation accuracy of reference junction ±1°C

■Resistance bulb

Stipulated current Approx. 0.25mA
 Lead wire resistance tolerance level 5Ω or less per wire (Resistance of three lines should be equal)
 Influence of lead-wire 5Ω or less per wire 0.2%FS
 10Ω or less per wire 0.5%FS
 20Ω or less per wire 1.0%FS
 Measuring range Refer to 5-5 measuring range code table.

■Voltage (mV)

Input resistance 500kΩ or more
 Input voltage range Refer to 5-5 measuring range code table.
 ■Current input (mA)
 Reception resistance 60Ω or less (built-in)
 Input range Refer to 5-5 measuring range code table.

Control

Control system PID control with an auto tuning function, or ON-OFF operation
 Proportional band (P) OFF and 0.1~999.9% of measuring range (ON-OFF operation by OFF setting)
 ON-OFF Differential-gap (DFL,DFH) 1~999 unit
 Integration Time (I) OFF, 1~6000 seconds (PD operation by OFF setting) } P operation if both I and D are OFF.
 Derivative time (D) OFF, 1~3600 seconds (PI operation by OFF setup)
 Manual Reset (MR) ±50.0% (effective when set as I = OFF)
 Output limiter (OL, OH) 0.0~100.0% (OL<OH) (set resolution 0.1)
 Soft start OFF, 0.5~120.0 seconds (set resolution 0.5)
 Proportional period 0.5~120.0 seconds (set resolution 0.5)
 Control output characteristic Possible to choose either RA (heating) or DA (cooling)
 Manual output 0.0~100.0% (set resolution 0.1)
 ■Control output 1
 Contact Normal open (1a) 250VAC / 30VDC 2A (resistance load)
 Voltage pulse (SSR drive) 13±2V DC MAX20mA
 Current 4 - 20mA DC load resistance 500Ω or less, Display accuracy ±1% (accuracy maintenance range 23°C±5°C),
 Load regulation ±0.2%, resolution approx. 1/10000

Event 1, 2 (Option)

Output rating Contact Normal open (1a) 250VAC / 30VDC 2A (resistance load, EV1・EV2 and common)
 Kind of event Refer to following table.

Function	Character	Note
No allotment	<i>non</i>	
Upper limit absolute value Alarm	<i>HA</i>	
Lower limit absolute value alarm	<i>LA</i>	
Scale over alarm	<i>So</i>	HHHH, LLLL, B---- Operates, when displayed.
Upper limit deviation value Alarm	<i>Hd</i>	
Lower limit deviation value alarm	<i>Ld</i>	
Within deviation alarm	<i>cd</i>	
Without deviation alarm	<i>od</i>	
RUN signal	<i>run</i>	Operates during FIX in operation.

Setting range Upper limit absolute value alarm, Lower limit absolute value alarm within measuring range
 Upper limit deviation alarm, Lower limit deviation alarm -1999~2000 unit
 Within deviation alarm, without deviation alarm 0~2000unit

Standby operation OFF No standby operation
 1 Only at the Time of Power-on, standby operation
 2 At the Time of power switch on, each alarm operating point is changed, deviation alarm's execution SV is changed, and RUN/STBY is switched over standby operation, at the time of AUTO/MAN switchover

Latching Alarm operation maintenance function
 (Release is done by key operation or power OFF. In the case of release by power OFF, all alarms are called off simultaneously)

Differential gap 1~999 unit

Output characteristic Choose from normal open (NO) or normal closing (NC).
 If NC is chosen and power is turned on, relay becomes ON within 1.5 second and becomes OFF at event power range.

■Delay function
 Delay time OFF, 1~8000 second
 Time accuracy ±(0.67% of Setup time + 1 second)

■Timer function
 ON time 1~600
 OFF time 0~600
 Unit of timer minute or second
 Time accuracy ±(0.67% of Setup time + 1 second)
 Break in the timer operation Acceptable at event turns off (Timer 1 mode) or unacceptable(Timer 2 mode)

Communication (Option)

Communicative type EIA standard RS-485
 Communication system Two-wire system half duplex multi-drops (bus) system
 Synchro system Asynchronous system
 Communication distance Maximum 500m (depends on conditions)
 Communication Speed 9600 or 19200 bps
 Data format Start 1bit, Stop 1 or 2 bits, Data length 8 bits, Parity without, odd number, even number
 Slave address 1~255
 Master mode function None
 Parameter preservation mode Choose from RAM, MIX and EEP mode.
 Error detection SHIMAX Standard Choose from None, ADD, complement of ADD +2, exclusive OR
 MODBUS RTU CRC-16
 MODBUS ACII LRC

Flow control None
 Delay 1~250ms (resolution 1ms)
 Communication code ASCII code or binary code
 Protocol SHIMAX Standard or MODBUS ASCII, MODBUS RTU protocol
 Termination resistance 120Ω (external connection)
 Number of connection Maximum 32 sets (depends on conditions, host is included)

General specification

Data retention	Non-volatile memory (EEPROM)		
Temporary dead time	No influence within 0.02 second 100% dip		
Use environmental condition			
Temperature	0~50 °C		
Humidity	Below 90%RH (no dew condensation)		
Height	Altitude of 2000m or less		
Category	II		
Contamination degree	2		
Storage temperature Conditions	-20~65 °C		
Supply voltage	100~240V (90~264V) AC 50/60Hz		
Power consumption	100~240V AC Maximum 9VA		
Insulated class	Class I apparatus		
Input noise removal ratio	Normal 40dB or higher		
Impulse-proof noise	Power-source Normal 100ns/1μs±1500V		
Insulation resistance	Between input/output terminal and power supply terminal	500V DC 20MΩ or higher	
	Between communication and other input/output terminals	500V DC 20MΩ or higher	
Withstand voltage	Between input/output terminal and power supply terminal	1800V AC 1 minute	
	Between communication and other input/output terminals	500V AC 1 minute	
	Between control output1 (Voltage pulse or current) and other input/output terminals	500V AC 1 minute	
Case material	PPO or PPE		
Case color	Light gray		
Outside dimension	MAC10A	H96×W96×D69mm (depth in panel 65mm)	
	MAC10B	H96×W48×D66mm (depth in panel 62mm)	
	MAC10C	H72×W72×D69mm (depth in panel 65mm)	
	MAC10D	H48×W48×D66mm (depth in panel 62mm)	
Thickness of applied panel	1.2~2.8mm		
Size of attachment hole		Individually attachment	Horizontal plural proximity attachment (N=number of equipment)
	MAC10A	H92×W92mm	W(96×N-4) mm H92mm
	MAC10B	H92×W45mm	W(48×N-3) mm H92mm
	MAC10C	H68×W68mm	W(72×N-4) mm H68mm
	MAC10D	H45×W45mm	W(48×N-3) mm H45mm
Mass	MAC10A	About 220g	
	MAC10B	About 160g	
	MAC10C	About 160g	
	MAC10D	About 120g	
Isolation	Between event output 1 and 2 is not insulated. Others are basic insulation or functional insulation. Refer to the following insulation block chart		

Insulation block chart

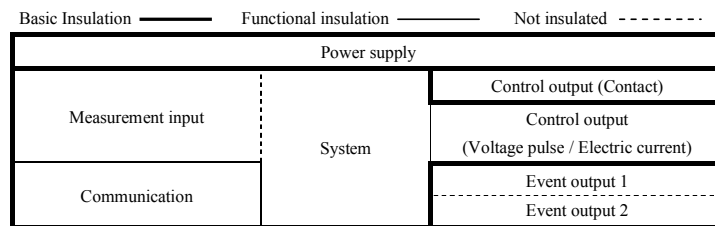

The contents of this instruction are subject to change without notice.

SHIMAX CO.,LTD.

Head Office 190 shimoniiyachi, aza, yotsuya, Daisen-shi, Akita 014-0102 Japan
 Phone +81-187-86-3400 FAX +81-187-62-6402
 URL <http://www.shimax.co.jp> E-MAIL info@shimax.co.jp

PRINTED IN JAPAN